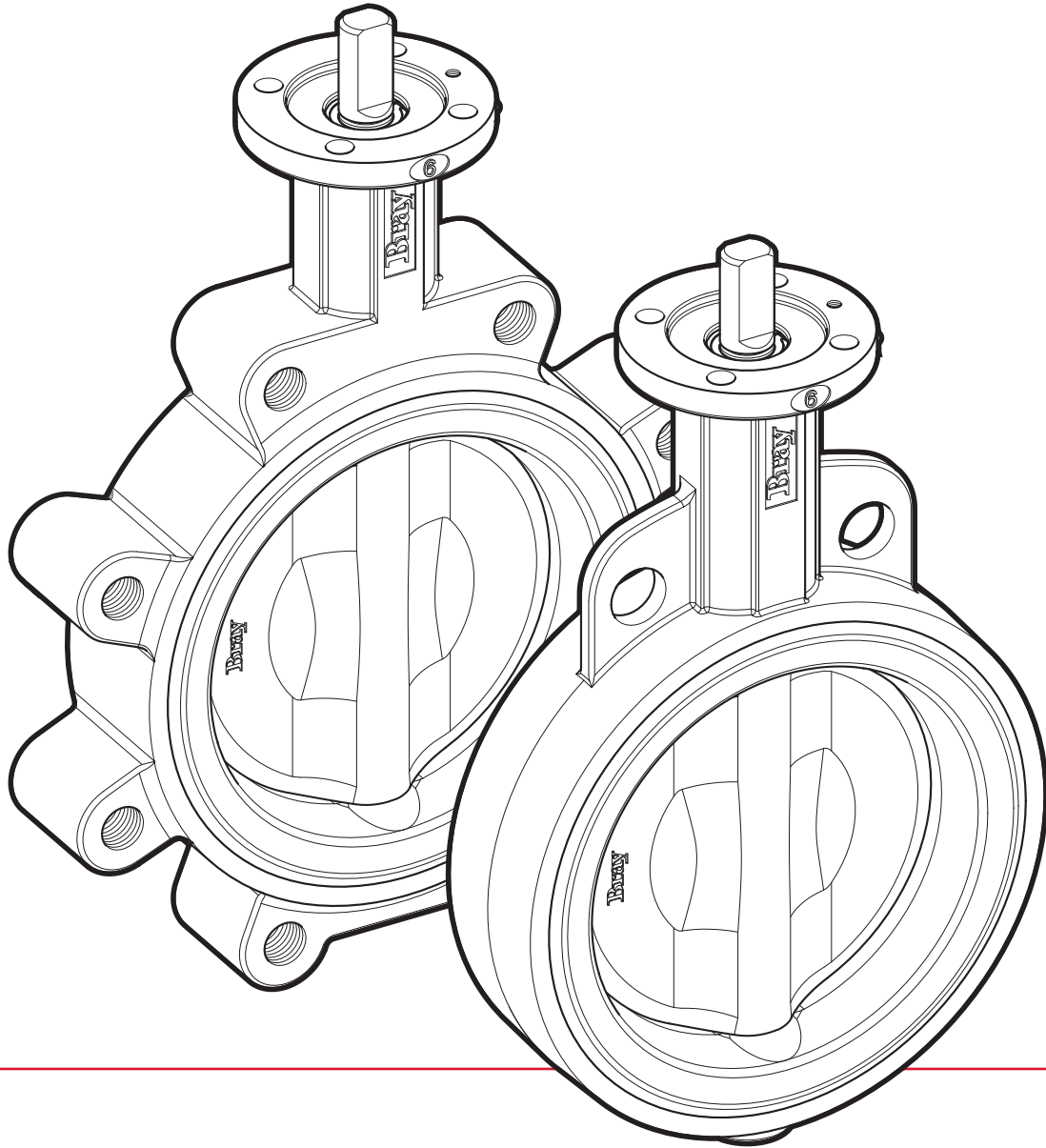


---

**3-Cx**

# RESILIENT SEATED BUTTERFLY VALVE

Installation, Operation, and Maintenance Manual



## CONTENTS

1.0	DEFINITION OF TERMS . . . . .	.3
2.0	INTRODUCTION . . . . .	4
3.0	PARTS IDENTIFICATION. . . . .	.5
4.0	VALVE IDENTIFICATION. . . . .	.6
5.0	QUALIFIED PERSONNEL . . . . .	.7
6.0	HANDLING REQUIREMENTS . . . . .	.8
7.0	STORAGE . . . . .	.9
8.0	LIFTING . . . . .	11
9.0	INSTALLATION CONSIDERATIONS . . . . .	12
10.0	INSTALLATION PROCEDURE . . . . .	18
11.0	OPERATION. . . . .	21
12.0	ACTUATOR REMOVAL AND REMOUNTING. . . . .	.22
13.0	TROUBLESHOOTING . . . . .	.23
14.0	RETURN MERCHANDISE AUTHORIZATION. . . . .	.24

**READ AND FOLLOW THESE INSTRUCTIONS CAREFULLY.  
SAVE THIS MANUAL FOR FUTURE USE.**

## 1.0 DEFINITION OF TERMS

1.1 All information within this manual is relevant to the safe operation and proper care of your Bray valve. Please understand the following examples of information used throughout this manual.

## X.X IDENTIFIES CHAPTER HEADING

X.XX Identifies and explains sequential procedure to be performed.

**NOTE:** Provides important information, useful tips, and recommendations related to a procedure.

## SAFETY STATEMENTS

The terms DANGER, WARNING, CAUTION, and NOTICE are used in this document to prevent unwanted consequences. Standard symbols and classifications are:



### DANGER

Indicates an immediate hazardous situation which, if not avoided, **will** result in death or serious injury and/or property damage.



### WARNING

Indicates a potentially hazardous situation which, if not avoided, **could** result in death or serious injury and/or property damage.



### CAUTION

Indicates a potentially hazardous situation which, if not avoided, **may** result in minor or moderate injury and/or property damage.



### NOTICE

Indicates and provides additional technical information which may not be obvious, even to qualified personnel. The term is not used for personal injury hazards or warnings, but can be used to indicate possible equipment or property damage.

1.2 Compliance with other notes — regarding transport, assembly, operation & maintenance, and about technical documentation (e.g., in the operating instructions, product documentation, or on the product itself) — is essential, to avoid faults which can directly or indirectly cause severe personal injury or property damage.

## 2.0 INTRODUCTION



### NOTICE

Failure to follow these procedures could affect product warranty.

**Read and follow these instructions carefully and keep this manual in a safe place for future reference.**

Based on over thirty years experience in the butterfly valve industry, Bray can state without question the majority of all field problems for resilient seated butterfly valves are directly related to poor installation procedures. For this reason, it is very important all distributors educate their customers regarding proper installation of resilient seated butterfly valves.

## 2.1 Butterfly Valve Seat/Disc Function

Before reviewing the proper installation, maintenance, and repair procedures for resilient seated butterfly valves, let's discuss the seat-disc function of a butterfly valve. The seat in a resilient seated butterfly valve has a molded tear drop profile on its flange face. **As a result, no gaskets are required as this profile serves the function of a gasket.** The flange face and molded profile of the seat extend beyond the body face-to-face to ensure sealing at the flange faces.

The seat inside diameter (I.D.) of all resilient seated butterfly valves is smaller than the disc outside diameter (O.D.) This difference, the disc-seat interference, has been engineered so as to be the basis for pressure rating capability and the related seating/unseating torques.

Finally, unlike many valve types, the resilient seated butterfly valve's disc actually extends beyond the face of the valve body at given angles of opening (say, 30° or more) when installed between flanges.



### CAUTION

It is very important before installation to ensure the critical chordal dimension of the disc at the full open position is less than the adjacent pipe flange I.D. (Refer to 3-Cx Technical Sales Manual for chordal dimensions).

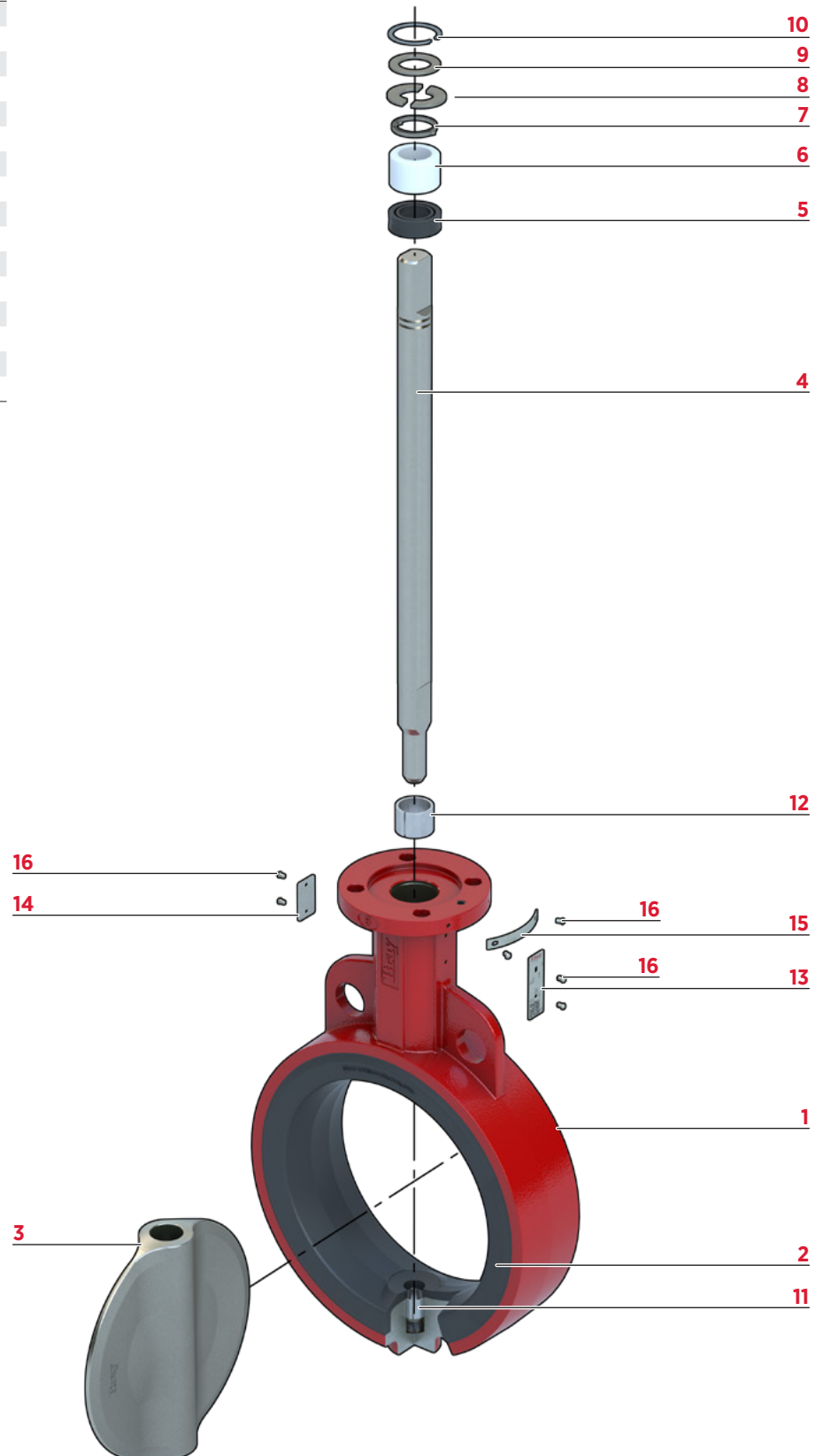
# 3-Cx RESILIENT SEATED BUTTERFLY VALVES

Installation, Operation and Maintenance Manual



## 3.0 PARTS IDENTIFICATION

ITEM	DESCRIPTION
1	Body
2	Seat (molded-in)
3	Disc
4	Stem
5	Stem Seal
6	Stem Bushing
7	Anti-static device
8	Split Ring
9	Thrust Washer
10	Retaining Ring
11	Lower Stem Bearing
12	Upper Stem Bearing
13	Identification Tag
14	Certification Tag
15	Torque Tag
16	Drive Screw



### 4.0 VALVE IDENTIFICATION



#### NOTICE

- > Ensure the box is not damaged externally.
- > Remove the valve from the packaging and check for any damage to the valve and its components during transit.
- > Report any damage or discrepancies immediately.
- > Every valve has an identification tag and must not be removed or covered, so that the installed valve remains identifiable.
- > Depending on the region, the valve identification tag may vary.

- 4.1** All valves, actuators, or control products are provided with an identification tag that is unique to each device.

All products for the Cx Line feature a digital valve identification tag. The electronic tagging system — **Bray DIGI-ID™** — ensures that each valve is uniquely and easily identifiable by simply scanning the QR Code on the product identification tag. This allows the operator to gain instant access to all relevant product information. This solution is in accordance with the DIN EN IEC 61406 (DIN Spec 91406) standard.



Scan code for more information  
about Bray DIGI-ID™

### 5.0 QUALIFIED PERSONNEL



#### NOTICE

Failure to follow these procedures could affect product warranty.

**5.1** A **qualified person** in terms of this document is one who is familiar with the installation, commissioning, and operation of the device and who has appropriate qualifications, such as:

- > Is trained in the operation and maintenance of electrical and mechanical equipment and systems in accordance with established safety practices.
- > Is trained or authorized to energize, de-energize, ground, tag, and lock electrical circuits and equipment in accordance with established safety practices.
- > Is trained in the proper use and care of personal protective equipment (PPE) in accordance with established safety practices.
- > In cases where the device is installed in a potentially explosive (hazardous) location — is trained in the commissioning, operation, and maintenance of equipment in hazardous locations.

**5.2** **Additional information** about 3-Cx valves — including application data, engineering specifications, and actuator selection — is available from your local Bray distributor or sales representative.

### 6.0 HANDLING REQUIREMENTS



#### WARNING

A potential hazard exists with handling valves. Failure to handle valves properly may cause a valve to shift, slip or fall causing serious injury or death and/or equipment damage.



#### CAUTION

Must be taken during handling to avoid this equipment passing over workers, or over any other place where a possible fall could cause injury or damage.

For handling and/or lifting, the lifting equipment (fasteners, hooks, etc.) must be sized and selected while taking into account the product weight indicated in our packing list and/or delivery note. Lifting and handling must be performed only by qualified personnel.

Fasteners must be protected by plastic covers in sharp corner areas.

In all cases, local safety regulations must be respected.

### 6.1 Packed Valves

**Crates:** Lifting and handling of the packed valves in crates will be carried out by a fork lift truck, by means of the appropriate fork hitches.

**Cases:** The lifting of packed valves in cases will be carried out in the lifting points and in the center of gravity position which has been marked. The transportation of all packed material must be carried out safely and following the local safety regulations.

### 6.2 Unpacked Valves

Lifting and handling of valves should be carried out by using appropriate means and observing carrying limits. Handling must be carried out on pallets, protecting all machined surfaces to avoid any damage.

With large bore valves, rigging the load must be carried out by using the appropriate tools to prevent the valve from falling or moving during the lifting and handling.



### 7.0 STORAGE



#### NOTICE

The packaging is designed to protect the valve only during shipping. If you are not installing the valve immediately after delivery, then you must store it according to these requirements.

Failure to follow these procedures could affect product warranty.

The seat, disc, stem and bushing of the resilient seated butterfly valve should be coated with silicone lubricant unless specified otherwise.

### 7.1 Short-Term Storage

Short-term storage is defined as storage of valves to allow for project construction and will be installed within a relatively short amount of time (typically one to three months). During short-term storage, the following is required:

The preferred storage location is a clean, dry, protected warehouse. Do not expose the valve to temperature extremes.

End protectors shall remain on the valve ends to prevent the entrance of dirt, debris, or insects/wildlife and should only be removed at the time of valve installation.

Goods shall remain in the original shipping container with the original packaging materials. This packaging method will not protect valves that will be stored outside, uncovered, and unprotected.

Storage of valves in an open, uncovered area is permissible, but requires provisions for inclement weather. The product must be elevated from the ground on a pallet, a shelf, or other suitable surface, and must be covered with a secure, waterproof tarp.



#### CAUTION

**Do not** stack the valves on top of each other.

Manually actuated valves may be stored in the vertical or horizontal position. For air or hydraulic actuated valves, the preferred orientation is with the valve and cylinder in the vertical position. Access ports should be secured to prevent unauthorized entry and prevent contamination.

### 7.2 Long-Term Storage

Long-term storage is defined as storage of valves longer than three months. During long-term storage, the following is required:

The storage location shall be a clean, dry, protected warehouse. Do not expose the valve to temperature extremes.

End protectors shall remain on the valve ends to prevent the entrance of dirt, debris, or insects/wildlife and should only be removed at the time of valve installation.

Product shall remain in the original shipping container with the original packaging materials.



### CAUTION

**Do not** stack the valves on top of each other.

Manually actuated valves may be stored in the vertical or horizontal position. For air or hydraulic actuated valves, the preferred orientation is with the valve and cylinder in the vertical position. Access ports should be secured to prevent unauthorized entry and prevent contamination.

Valves and equipment containing elastomers, including o-rings, must be stored in a climate-controlled warehouse according to SAE-ARP5316D requiring:

- > The ambient relative humidity to be less than 75%.
- > No exposure from direct ultraviolet or sunlight.
- > Protection from ozone generating equipment or combustible gases and vapors.
- > Storage at temperatures below 38°C (100°F), away from direct sources of heat. Preferred temperature range from 4°C to 29°C (40°F to 85°F). If a component is cooled below 15°C (59°F), the entire valve assembly should be allowed to rise above 20°C (68°F) before installing into service.
- > No exposure to ionizing radiation.

### 7.3 Storage Inspection

Visual inspection shall be performed on a quarterly basis and results recorded. Inspection, as a minimum, shall include reviewing the following:

- > Packaging.
- > Flange covers.
- > Dryness.
- > Cleanliness.

Disc should be positioned at 10° open and the valves should be opened and closed once every 3 months.

# 3-Cx RESILIENT SEATED BUTTERFLY VALVES

Installation, Operation and Maintenance Manual



## 8.0 LIFTING



### WARNING

A potential hazard exists with handling valves. Failure to handle valves properly may cause a valve to shift, slip, or fall — causing serious injury or death and/or equipment damage.



### NOTICE


The following information is for reference purposes only.

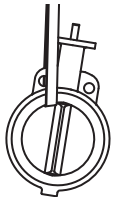
- > Always use safe and proper techniques for lifting and support.
- > Lift with properly rated lifting equipment.
- > DO NOT lift valves with any adjoining pipe or other equipment attached.
- > Follow jurisdictional safety requirements.


Figure 01: Approved lifting configurations.

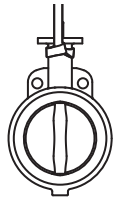
### NOTES:


- > Keep body level when lifting.
- > Ensure strap is secure around valve.
- > Ensure strap is not twisted.

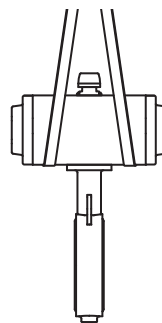
 **INCORRECT**  
Straps through seat opening.




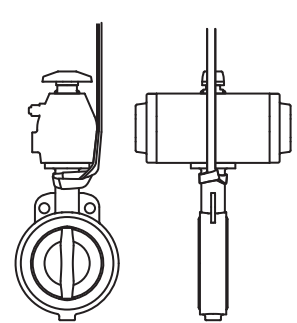
 **CORRECT**  
Straps around body or neck.



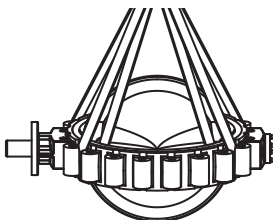
 **INCORRECT**  
Straps around actuator body.




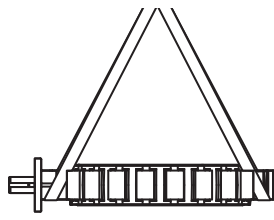
 **CORRECT**  
Straps around body or neck.




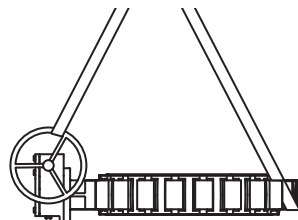
 **INCORRECT**  
Straps through seat opening.



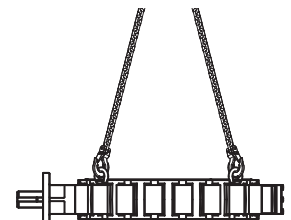
 **CORRECT**  
Straps around body.



 **INCORRECT**  
Straps through gear handwheel.



 **CORRECT**  
Chains with lifting lugs.



## 9.0 INSTALLATION CONSIDERATIONS



### WARNING

- > Only qualified personnel are allowed to install the valve.
- > Verify line is depressurized before installing, removing, or repairing a valve or operator.
- > Do not pressurize the line without an operator on the valve.
- > The device generates a large mechanical force during normal operation.
- > Observe all applicable safety regulations for valves installed in potentially explosive (hazardous) locations.



### CAUTION

- > Risk of crushing the hand or fingers.
- > Do not operate a valve with actuator until it is installed.
- > Do not operate a valve installed at the open end of a pipe section.



### NOTICE

For the installation of valves in a pipeline, the same instructions apply as for the flange connection of pipes and similar pipeline elements.

The following instructions apply additionally to valves.

## 9.1 Piping and Flanged Compatibilities

### 9.1.1 Piping

These valves have been engineered so that the critical disc chordal dimension at the full open position will clear the adjacent inside diameter of most types of piping, including Schedule 40, lined pipe, heavy wall, etc.

**NOTE:** It is important to verify valve disc clearance with adjacent piping prior to installation.

### 9.1.2 Metal Flanges

This butterfly valve has been designed to be suitable for EN 1092 flanges. Proper alignment between flanges is critical to good performance. The flange bolts must also be evenly tightened around the circumference of the valve, providing consistent flange compression of the molded profile on the seat face.

Since Bray does not recommend the use of gaskets between flanges, a uniform flange face is critical to proper valve sealing.

## 9.1.3 Non-Metallic Flanges

When non-metallic flanges, such as plastic or PVC, are used with butterfly valves, care must be taken not to over-tighten the flange bolts. The inherent flexibility of these non-metallic flange materials allow them to be over-tightened relatively easily. Flexing caused by this over-tightening can actually reduce the compression of the valve between the flanges, causing leaks between the valve and the flange face. Proper alignment and firm, even, but not excessive tightening of flange bolts are especially important with non-metallic flanges. In some cases, non-metallic flanges of low quality will not mate tightly with butterfly valves regardless of the care taken during installation.

## 9.2 Valves with Spring Return Actuators

### 9.2.1 Fail Closed Assemblies

If the valve is supplied with an actuator, the butterfly valve is shipped in the full closed position (as no air pressure is present to compress the springs and open the disc).



#### CAUTION

Installing the valve with the disc in the full closed position may create a compression set on the seat causing higher than expected torques or premature seat failure. It is recommended to:

- > Remove the actuator. Be sure to scribe the valve and actuator to ensure the re-installed actuator is in the exact same quadrant as originally configured
- > Install the valve per the attached installation tag instructions
- > Re-install the actuator ensuring it is in the proper quadrant

### 9.2.2 Fail Open Assemblies

If the valve is supplied with an actuator, the butterfly valve disc is shipped in the full open position (as no air pressure is present to compress the springs and close the valve disc.) The sealing surface, or disc edge, is therefore exposed. Damage to that surface will cause premature seat failure.



#### CAUTION

Use caution installing the valve, being careful not to damage the disc edge. It is recommended to:

- > Remove the actuator. Be sure to scribe the valve and actuator to ensure the re-installed actuator is in the exact same quadrant as originally configured.
- > Rotate disc to the closed position.
- > Install the valve per the attached installation tag instructions.
- > Rotate disc to fully open position.
- > Re-install the actuator ensuring it is in the proper quadrant.

#### 9.3 Valve Location

Butterfly valves should be installed if possible a minimum of 6 pipe diameters from other line elements, i.e., elbows, pumps, valves, etc. of course, 6 pipe diameters are not always practical, but it is important to achieve as much distance as possible.

Where the butterfly valve is connected to a check valve or pump, use an expansion joint between them to ensure the disc does not interfere with the adjacent equipment.

#### 9.4 Valve Orientation



##### NOTICE

Bray does not recommend valves be installed in an upside-down position.

In general, Bray recommends the butterfly valve be installed with the stem in the vertical position and the actuator mounted directly above the valve; however, there are those applications as discussed below where the stem should be horizontal.

For slurries, sludge, mine tailing, pulp stock, dry cement, and any media with sediment or particles, Bray recommends the butterfly valve to be installed with the stem in the horizontal position with the lower disc edge opening in the downstream direction.

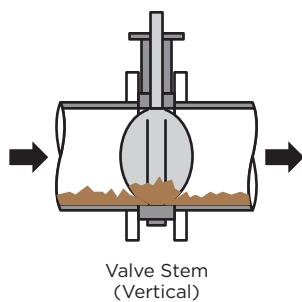
**(Figure 02)**

**Figure 02:** Valve orientation for media with sediment.



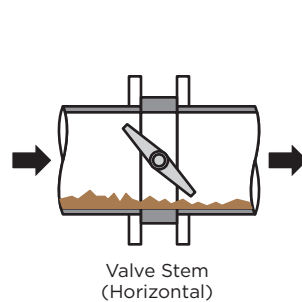
##### INCORRECT

Sediment buildup around lower disc and hub.



##### CORRECT

Sediment passes under disc.

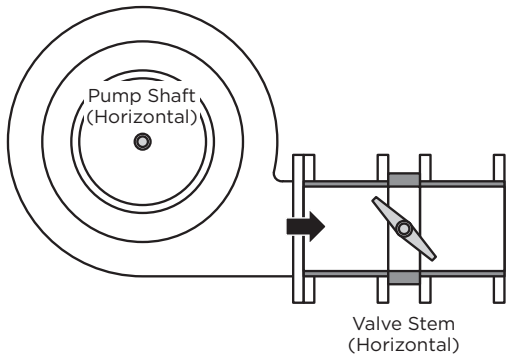


## 9.4 Valve Orientation (Continued)

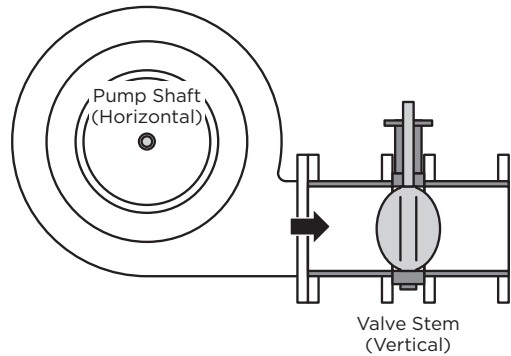
Butterfly valve, located at the discharge of a pump should be oriented as follows:

**Figure 03:** Centrifugal pump (with pump shaft horizontal).

**INCORRECT**  
Valve stem horizontal.

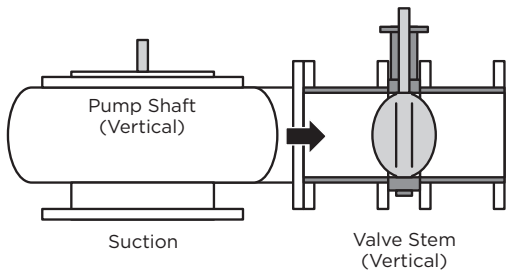


**CORRECT**  
Valve stem vertical.

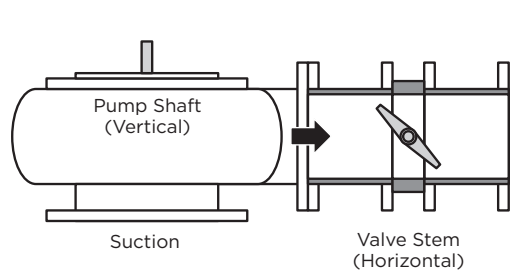


**Figure 04:** Centrifugal pump (with pump shaft vertical).

**INCORRECT**  
Valve stem horizontal.

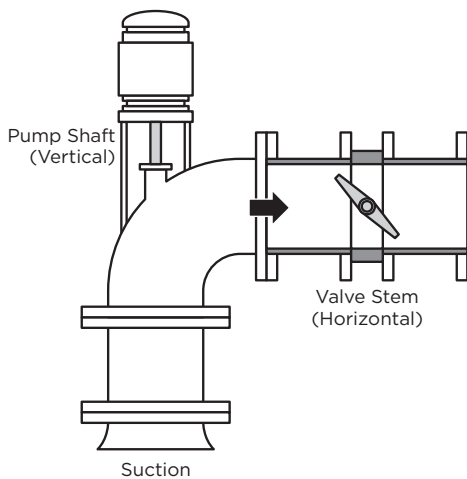


**CORRECT**  
Valve stem vertical.

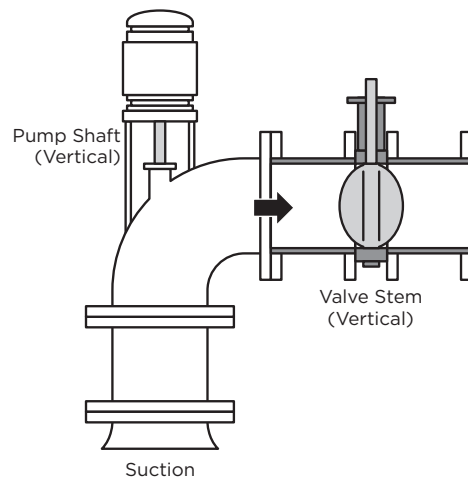


**Figure 05:** Axial pump (with pump shaft vertical).

**INCORRECT**  
Valve stem horizontal.




**CORRECT**  
Valve stem vertical.

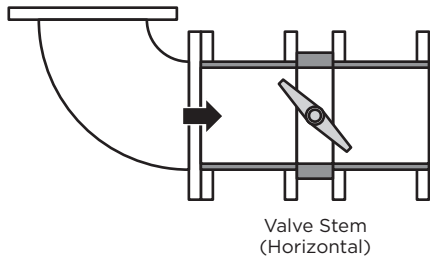


## 9.4 Valve Orientation (Continued)

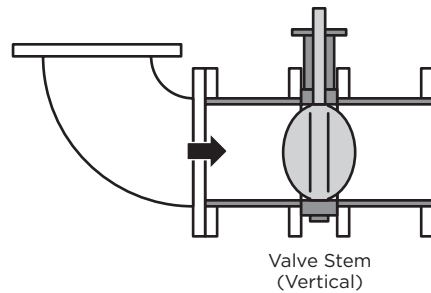
Butterfly valve, located at the discharge of a pump should be oriented as follows:

**Figure 06:** Bend.

 **INCORRECT**  
Valve stem horizontal.

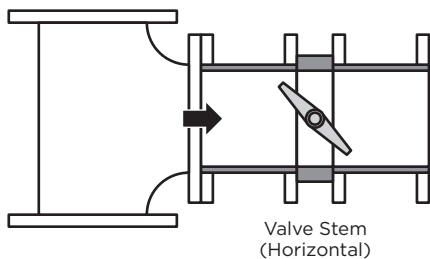


 **CORRECT**  
Valve stem vertical.

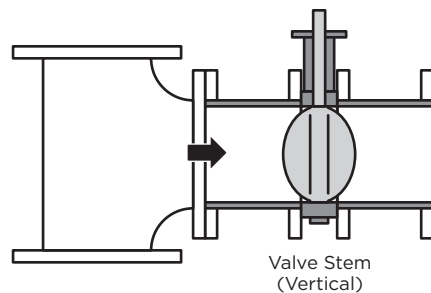


**Figure 07:** Tee.

 **INCORRECT**  
Valve stem horizontal.

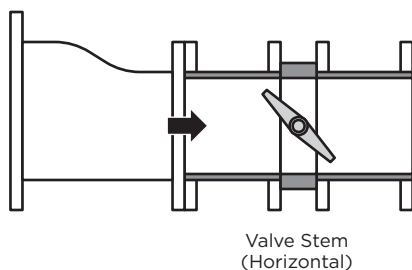


 **CORRECT**  
Valve stem vertical.

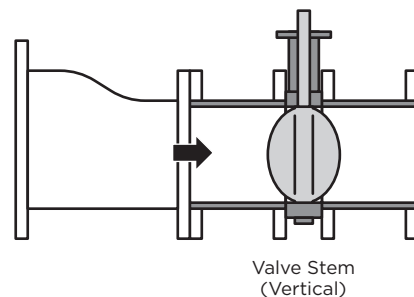


**Figure 08:** Reducer.

 **INCORRECT**  
Valve stem horizontal.



 **CORRECT**  
Valve stem vertical.





#### 9.4 Valve Orientation (Continued)

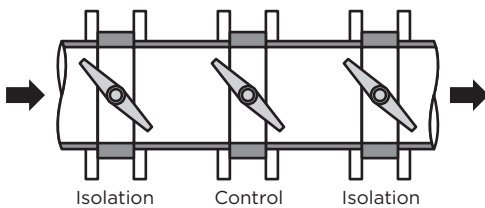
Butterfly valve, located at the discharge of a pump should be oriented as follows:

**Figure 09:** Control/Isolation combination.



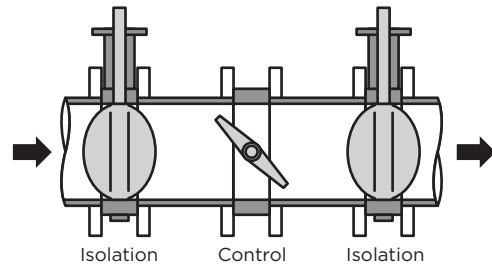
**INCORRECT**

Combination with all valve stems in the same direction accelerates possible noise, vibration, and erosion problems.



**CORRECT**

Combination with the stem of the control valve at right angle to those of other valves tends to cancel the drift of the fluid, and reduces noise, vibration, and erosion.



## 10.0 INSTALLATION PROCEDURE

### 10.1 General Installation

- 10.1.1 Make sure the pipeline and pipe flange faces are clean. Any foreign material such as pipe scale, metal chips, welding slag, welding rods, etc., can obstruct disc movement or damage the disc or seat.
- 10.1.2 The Bray elastomer seat has a molded tear drop profile on the face of the seat. **As a result, no gaskets are required as this profile serves the function of a gasket.**
- 10.1.3 Ensure that the valve disc has been positioned to a partially open position (approximately 10° open) with the disc edge about 10 mm ( $\frac{3}{8}$  to  $\frac{1}{2}$  inch) inside the face of the seat.

**Note:** See **Section 9.2** for special consideration for valves with spring return actuators.

- 10.1.4 Align the piping, then spread the pipe flanges a distance apart to permit the valve body to be easily placed between the flanges without contacting the pipe flanges. **(Figure 10)**



#### WARNING

Never pick up a valve, actuator, or gear assembly by the actuator or gear. Instead, use the valve locating holes, or nylon straps around the neck of the valve to pick up the entire assembly.

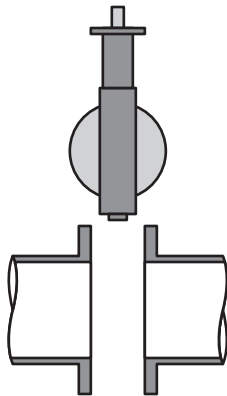
**Figure 10:** Spread flanges apart for valve clearance.



#### INCORRECT

Pipe not spread; disc opened beyond valve body face.

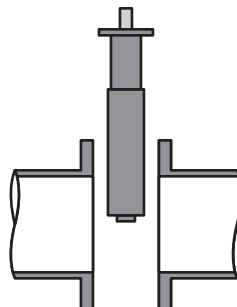
**Results:** Disc edge damaged when it hits pipe flange.



#### CORRECT

Pipe spread and aligned; disc rotated within body face.

**Results:** No undesirable beginning seating/unseating torque; disc edge protected.



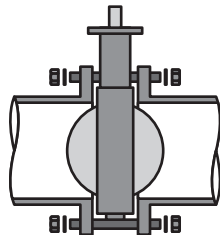
### 3-Cx RESILIENT SEATED BUTTERFLY VALVES

Installation, Operation and Maintenance Manual



10.1.5 Insert the valve between the flanges taking care not to damage the seat faces. Install flange bolts or studs to center the valve, but do not tighten, ensuring the disc has clearance for centering.

**Figure 11:** Insert and center valve.



10.1.6 To check for proper alignment, carefully open the disc to the full open position, making sure the disc does not hit the adjacent pipe I.D. (**Figure 12**)

**Figure 12:** Check for proper alignment of valve and flanges.



**INCORRECT**

Piping misaligned.

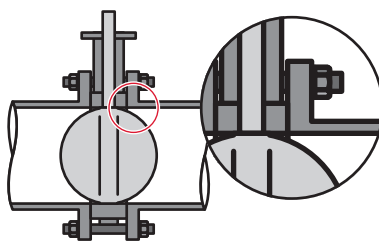
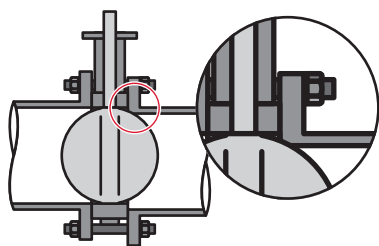
**Results:** Disc O.D. strikes pipe I.D. causing disc edge damage, increased torque, and leakage.



**CORRECT**

Piping aligned properly when bolts tightened; disc in full open position.

**Results:** Disc clears adjacent pipe I.D.; liner face seals properly; no excessive initial torque.



10.1.7 Now systematically remove jack bolts or other flange spreaders, and hand-tighten the flange bolts.

10.1.8 Very slowly close the valve disc to ensure disc edge clearance from the adjacent pipe flange I.D.

### 3-Cx RESILIENT SEATED BUTTERFLY VALVES

Installation, Operation and Maintenance Manual

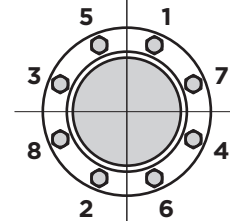


- 10.1.9 Open the disc to full open, then tighten all flange bolts per specification as shown in **Table 01** and **Figure 13**.
- 10.1.10 Finally, repeat a full close to full open rotation of the disc to ensure proper clearances.

**Table 01:** Flange Bolt Tightening Torque

Valve Size		Normal Torque <sup>1</sup>	Valve Size		Normal Torque <sup>1</sup>
NPS		lbf-ft	DN		N m
2		30	50		40
2½		30	65		40
3		35	80		50
4		35 to 40	100		50 to 55
5		35 to 45	125		50 to 60
6		35 to 50	150		50 to 65
8		45 to 55	200		60 to 75
10		55 to 75	250		75 to 100
12		65 to 110	300		90 to 150
14		75 to 120	350		100 to 165
16		75 to 120	400		100 to 165
18		85 to 130	450		115 to 175
20		85 to 130	500		115 to 175
24		100 to 150	600		135 to 205

**Figure 13:** Flange Bolt Tightening Pattern.



**Notes:**

<sup>1</sup> Maximum bolt torques shown for steel or alloy flanges. If installed between non-metallic flanges (FRP for example), follow the flange manufacturer’s recommended bolt torque.

**10.2 Installation Between Weld Flanges**

When resilient seated butterfly valves are to be installed between welding type flanges, care should be taken to abide by the following procedure to ensure no damage will occur to the seat.

- 10.2.1 Place the valve between the flanges with the flange bores and valve body aligned properly. The disc should be in the 10° open position.
- 10.2.2 Span the body with the bolts.
- 10.2.3 Take this assembly of flange-body-flange and align it properly to the pipe.
- 10.2.4 Tack weld the flanges to the pipe.
- 10.2.5 When tack welding is complete, remove the bolts and the valve from the pipe flanges and complete the welding of the flanges. Be sure to let the pipe and flanges cool before installing the valve.



**CAUTION**

Never complete the welding process (after tacking) with the valve between pipe flanges. This causes severe seat damage due to heat transfer.

## 11.0 OPERATION

### 11.1 Operation

Operation of the valve is done by turning the stem a quarter-turn (90 degree turn).

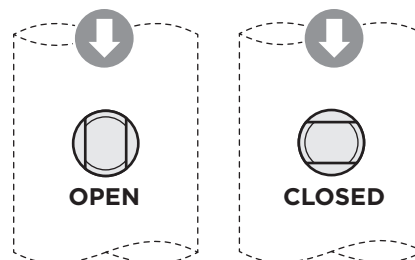
- > The stem is turned clockwise to close, counter-clockwise to open.

### 11.2 Valve Open/Closed Indication

#### Indication ( $\leq$ NPS 12 | DN 300)

- > Valve **OPEN** position: Flats of Double-D stem are **parallel** to pipeline.
- > Valve **CLOSED** position: Flats of Double-D stem are **perpendicular** to pipeline.

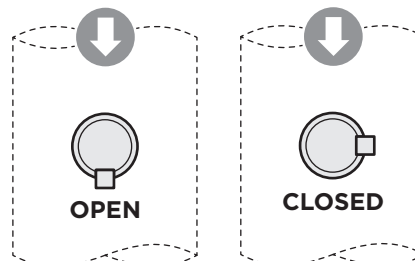
**Figure 14:** Indication of valve Open and Closed position. ( $\leq$  NPS 12 | DN 300)



#### Indication ( $\geq$ NPS 14 | DN 350)

- > Valve **OPEN** position: Key is **parallel** to pipeline.
- > Valve **CLOSED** position: Key is **perpendicular** to pipeline.

**Figure 15:** Indication of valve Open and Closed position. ( $\geq$  NPS 14 | DN 350)



#### CAUTION

Valves with actuators should be inspected for actuator/valve alignment. Misalignment will result in high operational torque and damage to valve stem and seals.

### 12.0 ACTUATOR REMOVAL AND REMOUNTING

#### 12.1 Removing Actuator

- 12.1.1 Refer to relevant actuator installation, operation, and maintenance instructions before proceeding.
- 12.1.2 Neutralize all energy sources (electrical, pneumatic or hydraulic pressure, and mechanical).
- 12.1.3 Support the actuator assembly before disconnecting it from the body assembly.
- 12.1.4 Unbolt the actuator assembly from valve body.
- 12.1.5 Lift actuator assembly off stem.

#### 12.2 Remounting Actuator

- 12.2.1 Before mounting an actuator on the valve body, verify that the segment rotation matches the actuator rotation and complies with the actuator failure mode requirements.
- 12.2.2 Slide the entire actuator assembly onto the stem.
- 12.2.3 Bolt actuator assembly to valve body.
- 12.2.4 Verify and set actuator stops.



#### **NOTICE**

Refer to the actuator IOM for necessary adjustments.

# 3-Cx RESILIENT SEATED BUTTERFLY VALVES

Installation, Operation and Maintenance Manual



## 13.0 TROUBLESHOOTING

SYMPTOM	POSSIBLE CAUSE	RECOMMENDED SOLUTION
<b>Stem leakage</b>	Seat is worn or damaged.	Remove valve and inspect. Replace valve if seat is damaged.
	Disc is damaged.	Remove valve and inspect. Replace valve if disc is damaged.
<b>Disc in fully closed position, seat leakage observed</b>	Seat is worn or damaged.	Remove valve and inspect. Replace valve if seat is damaged.
	Disc is damaged.	Remove valve and inspect. Replace valve if disc is damaged.
<b>High torque during valve seating and unseating</b>	Entrapped foreign media in pipeline prohibiting valve from seating.	a) Remove valve from service. b) Review disc to seat interface.
<b>Valve pops during open and close</b>	Superstructure fasteners loosened.	Tighten the superstructure fasteners.
	Insufficient air supply.	Pneumatic operated valves: Increase supply pressure.
	Solenoid valve dust accumulation.	Remove and clean solenoid valve.
	Piston rod seal damaged.	Replace seal.

**Note:** The 3-Cx is not intended to be field repairable. For further troubleshooting and repair options and information, please contact your local Bray representative.

### 14.0 RETURN MERCHANDISE AUTHORIZATION

**14.1** All products that are returned require a Return Merchandise Authorization (RMA). Contact a Bray representative for instructions and RMA forms to be completed prior to return of any product.

**14.2** The following information must be provided when submitting RMA.

- > Serial number
- > Part number
- > Month and year of manufacture
- > Actuator specifics
- > Application
- > Media
- > Operating temperature
- > Operating pressure
- > Total estimated cycles (since last installation or repair)

**NOTE:** Product information is provided on identification tag attached to device.



#### **NOTICE**

Materials must be cleaned and sanitized prior to return. MSDS sheets and Declaration of Decontamination are required.



---

SINCE 1986, BRAY HAS PROVIDED FLOW CONTROL SOLUTIONS FOR A VARIETY OF INDUSTRIES AROUND THE WORLD.

VISIT **BRAY.COM** TO LEARN MORE ABOUT BRAY PRODUCTS AND LOCATIONS NEAR YOU.

## **GLOBAL HEADQUARTERS**

**Bray International, Inc.**

13333 Westland East Blvd.

Houston, Texas 77041

Tel: +1.281.894.5454

All statements, technical information, and recommendations in this bulletin are for general use only. Consult Bray representatives or factory for the specific requirements and material selection for your intended application. The right to change or modify product design or product without prior notice is reserved. Patents issued and applied for worldwide. Bray® is a registered trademark of Bray International, Inc.

© 2023 BRAY INTERNATIONAL. ALL RIGHTS RESERVED. BRAY.COM

EN\_IOM\_3Cx\_20231016

---



**THE HIGH PERFORMANCE COMPANY**

**BRAY.COM**